

ООО "СЭЛКОМ"
Поставка образцов и промышленных партий.

Тел: +7 (495) 204-13-84

E-mail: sale@radiodetali.com

ProLight Opto Technology Corp.
No.89, Xi Yuan Rd., Zhongli Dist, Taoyuan City, Taiwan
Tel +886-3-4618618
Fax +886-3-4618677
sales@prolightopto.com

ProLight

LED solution provider

2021 Catalog

Index

General Lighting

- 02 Phenix 3535
- 04 Phenix3030
- 06 Proeon
- 08 CSP 1616
- 10 TunableWhite
- 12 WoD
- 14 Brill COB

Architecture / Entertainment

- 16 Mono Color LED
- 18 Multi Color in 1 LED
- 26 Spot Light
- 28 Effect Light
- 30 Studio Light

Automotive

- 32 Headlamp
- 33 Emitter
- 34 Warming Light

UV LED

- 36 UVA Quartz Lens
- 38 UVA Silicon Lens
- 40 UV module
- 41 UVB
- 42 UVC

47 Plant Growing

48 IR LED

Entertainment Lighting

UV curing

Plant Growing

Architectural Lighting

Automotive Lighting



Phenix 3535

● Standard 3535 package.

ООО "СэлКОМ"
Поставка образцов и промышленных партий.

Тел: +7 (495) 204-13-84

E-mail: sale@radiodetali.com



Watt	Part No.	Color	CRI	Test Current (mA)	Vf (Typ.)	CCT (Min.)	CCT (Max.)	2θ _{1/2}	Max Current (mA)	Bin Code
2	PK2E-2LWE-B2R7	White	70	350	3.1	5000 K	7000 K	130	700	W2/X1/X2*
	PK2E-2LWE-B2R8	White	80	350	3.1	5000 K	7000 K	130	700	W1/W2/X1/X2*
	PK2E-2LNE-B2R8	Neutral White	80	350	3.1	3800 K	5000 K	130	700	W1/W2/X1*
	PK2E-2LVE-B2R8	Warm White	80	350	3.1	2700 K	3250 K	130	700	V2/W1/W2*
	PK2E-2LWE-B2R7S	White	70	350	3.05	5000 K	6300 K	130	700	X1/X2/Y1*
	PK2E-2LNE-B2R7S	Neutral White	70	350	3.05	3800 K	5000 K	130	700	X1/X2/Y1*
3	PK2N-3LWE-SD	White	74	350	3.1	4100 K	10000 K	130	700	V2*/W1/W2/X1*
	PK2N-3LVE-R7	Warm White	70	350	3.1	2500 K	4100 K	130	700	V1/V2/W1/W2*/X1*
	PK2N-3LWE-R8	White	84	350	3.1	4100 K	10000 K	130	700	V1/V2/W1*
	PK2N-3LNE-R8	Neutral White	80	350	3.1	3500K	5000K	130	700	V1/V2/W1*/W2*
	PK2N-3LVE-R8	Warm White	80	350	3.1	2500 K	4100 K	130	700	U2/V1/V2/W1*/W2*
PK2N-3LVE-R95	Warm White	93	350	3.1	2500 K	4100 K	130	700	T2/U1/U2*/V1*/V2*	
4	PK2N-4LWE-SBVR8B	White	80	350	2.95	4750 K 5330 K	5340 K 6030 K	130	1000	V2*/W1/W2/X1*
	PK2N-4LNE-SBVR8B	Neutral White	80	350	2.95	3360 K 3840 K	3570 K 4120 K	130	1000	V2/W1/W2/X1*
	PK2N-4LVE-SBVR8B	Warm White	80	350	2.95	2660 K 2970 K	2790 K 3120 K	130	1000	V1/V2/W1/W2*
	PK2N-4LNE-SBVR9B	Neutral White	90	350	2.95	3360 K 3840 K	3570 K 4120 K	130	1000	U1/U2/V1/V2*/W1*
	PK2N-4LVE-SBVR9B	Warm White	90	350	2.95	2660 K 2970 K	2790 K 3120 K	130	1000	T2/U1/U2/V1*/V2*

Watt	Part No.	Color	CRI	Test Current (mA)	Vf (Typ.)	CCT (Min.)	CCT (Max.)	2θ _{1/2}	Max Current (mA)	Bin Code
5	PK2E-5LWE-BR7	White	70	350	3.05	5000 K	8050 K	130	1200	W1/W2/X1*
	PK2E-5LNE-R7	Neutral White	70	350	3.05	3800 K	5000 K	130	1200	W1/W2/X1*
	PK2E-5LVE-R7	Warm White	70	350	3.05	2700 K	3250 K	130	1200	V2/W1/W2*/X1*
	PK2E-5LWE-BR8	White	80	350	3.05	5000 K	8050 K	130	1200	V2/W1/W2*/X1*
	PK2E-5LNE-R8	Neutral White	80	350	3.05	3800 K	5000 K	130	1200	V2/W1/W2*/X1*
	PK2E-5LVE-R8	Warm White	80	350	3.05	2700 K	3250 K	130	1200	V1/V2/W1*/W2*
	PK2E-5LWE-BR8T	White	80	350	3.05	4750 K 5330 K	5340 K 6030 K	130	1200	V2/W1/W2*/X1*
	PK2E-5LNE-R8T	Neutral White	80	350	3.05	3850 K	4120 K	130	1200	V2/W1/W2*/X1*
	PK2E-5LVE-R8T	Warm White	80	350	3.05	2660 K 2970 K	2790 K 3120 K	130	1200	V1/V2/W1*/W2*
	PK2N-5LWE-BVR7	White	70	350	2.9	5000 K	7000 K	130	1500	X1/X2/Y1*
5	PK2N-5LNE-BVR7	Neutral White	70	350	2.9	3800 K	5000 K	130	1500	X1/X2/Y1*
	PK2N-5LWE-BVR8	White	80	350	2.9	5000 K	7000 K	130	1500	W2/X1/X2*
	PK2N-5LVE-BVR8	Warm White	80	350	2.9	2700 K	3250 K	130	1500	W1/W2/X1*
	PK2N-5LNE-SR8C	Neutral White	80	350	2.9	3360 K 3840 K	3570 K 4120 K	130	1500	W2/X1/X2*/Y1*
	PK2N-5LVE-SR8C	Warm White	80	350	2.9	2660 K 2970 K	2790 K 3120 K	130	1500	W1/W2/X1*/X2*
	PK2N-5LNE-SR9C	Neutral White	90	350	2.9	3360 K 3840 K	3570 K 4120 K	130	1500	V2/W1/W2*/X1*
	PK2N-5LVE-SR9C	Warm White	90	350	2.9	2660 K 2970 K	2790 K 3120 K	130	1500	U2/V1/V2*/W1*

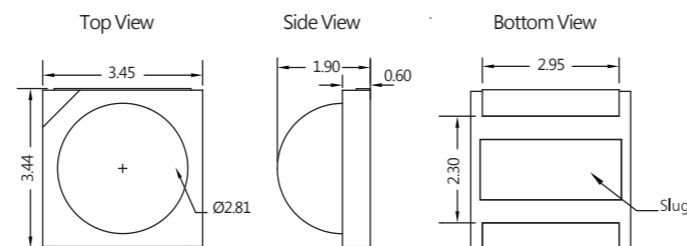

Bin Code- Phenix 3535 2W
Photometric Luminious(lm)

	V2	W1	W2	X1	X2	Y1
min	120	130	145	160	175	190
max	130	145	160	175	190	210

Bin Code- Phenix 3535 3W&4W&5W
Photometric Luminious(lm)

	T1	T2	U1	U2	V1	V2	W1	W2	X1
min	70	80	90	100	110	120	130	140	155
max	80	90	100	110	120	130	140	155	170

Phenix 3030

Standard 3030 package.



ООО "СэлКОМ"
Поставка образцов и промышленных партий.

Тел: +7 (495) 204-13-84
E-mail: sale@radiodetali.com

Preon



Watt	Part No.	Color	CRI	Test Current (mA)	Vf (Typ.)	CCT (Min.)	CCT (Max.)	2θ _{1/2}	Bin Code
	PW2N-1FWE-2SCR7A	White	70	150	6.4	4745 K	6950 K	120	V2/W1/W2*
	PW2N-1FNE-2SCR7A	Neutral White	70	150	6.4	3700 K	4250 K	120	V2/W1/W2*
	PW2N-1FVE-2SCR7A	Warm White	70	150	6.4	2850 K	3250 K	120	V1/V2/W1*
	PW2N-1FWE-N2SCR8A	White	80	150	6.4	4745 K	6950 K	120	V2/W1/W2*/X1*
	PW2N-1FNE-N2SCR8A	Neutral White	80	150	6.4	3250 K	4250 K	120	V2/W1/W2*/X1*
	PW2N-1FVE-N2SCR8A	Warm White	80	150	6.4	2580 K	3250 K	120	V1/V2/W1*/W2*
1	PW2N-1FWE-N2HCR9	White	90	150	6.4	4750 K	5300 K	120	U1/U2*/V1*
	PW2N-1FNE-N2HCR9	Neutral White	90	150	6.4	3700 K	4250 K	120	U1/U2*/V1*
	PW2N-1FWE-N2SCR9A	White	90	150	6.0	4745 K	6020 K	120	V2/W1*
	PW2N-1FNE-N2SCR9A	Neutral White	90	150	6.0	3250 K	4250 K	120	V1/V2/W1*
	PW2N-1FVE-N2SCR9A	Warm White	90	150	6.0	2580 K	3250 K	120	U2/V1/V2*
	PW2N-1FWE-N2SCR95A	White	95	150	6.0	4745 K	6010 K	120	V1/V2*/W1*
	PW2N-1FNE-N2SCR95A	Neutral White	95	150	6.0	3250 K	4250 K	120	U2/V1/V2*
	PW2N-1FVE-N2SCR95A	Warm White	95	150	6.0	2580 K	3250 K	120	U1/U2/V1*

Watt	Part No.	Color	CRI	Test Current (mA)	Vf (Typ.)	CCT (Min.)	CCT (Max.)	2θ _{1/2}	Bin Code
	PM2E-1LWE	White	70	350	3.3	410 K	10000 K	130	V2/W1/W2/X1*
	PM2E-1LVE-R8	Warm White	80	350	3.3	2700 K	4100 K	130	U2/V1/V2/W1*
1	PM2E-1LRE	Red	-	350	2.2	613.5 nm	631 nm	130	S1/S2/T1*
	PM2E-1LAE	Amber	-	350	2.2	587 nm	597 nm	130	S1/S2/T1/T2*/U1*
	PM2E-1LGE	Green	-	350	3.4	515 nm	535 nm	130	U1/U2/V1/V2*/W1*
	PM2E-1LBE	Blue	-	350	3.3	455 nm	475 nm	130	P/Q/R*

Bin Code- Phenix 3030 Photometric Luminioux(lm)

	U1	U2	V1	V2	W1	W2	X1
min	90	100	110	120	130	140	155
max	100	110	120	130	140	155	170

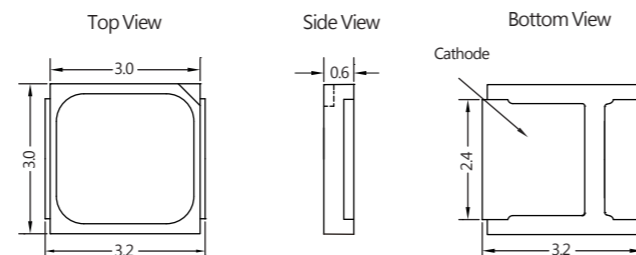

Bin Code- White Color Photometric Luminioux(lm)

	U2	V1	V2	W1	W2	X1
min	100	110	120	130	140	155
max	110	120	130	140	155	170

Bin Code- Mono Color Photometric Luminioux(lm)

	P	Q	R	S1	S2	T1	T2	U1	U2
min	23.5	30.6	39.8	51.7	58.9	67.2	76.6	87.4	99.6
max	30.6	39.8	51.7	58.9	67.2	76.6	87.4	99.6	113.6

General Lighting

CSP1616

- Support the highest drive current up to 1A.
- Available with dome lens or flat emitting surface.

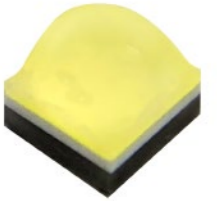
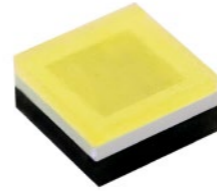

Watt	Part No.	Color	CRI	Test Current (mA)	Vf (Typ.)	CCT (Min.)	CCT (Max.)	2θ _{1/2}	Bin Code
3	PQ2A-3FWE-FCR9	White	92	350	3.0	4750 K	6970 K	130	U1/U2*
	PQ2A-3FVE-FCR9	Warm White	92	350	3.0	2580 K	3250 K	130	T2/U1*
	PQ2A-3FWE-FCR95	White	93	350	3.0	4750 K	6970 K	130	T2/U1*
	PQ2A-3FVE-FCR95	Warm White	95	350	3.0	2580 K	3250 K	130	T1/T2*
4	PQ2A-4FWE-FC	White	-	350	3.0	4800 K	6450 K	130	V1/V2/W1*

Watt	Part No.	Color	CRI	Test Current (mA)	Vf (Typ.)	CCT (Min.)	CCT (Max.)	2θ _{1/2}	Bin Code
4	PQ2N-4LWE-FC	White	70	350	3.0	4800 K	6450 K	130	V2/W1/W2*
	PQ2N-4LVE-FCR8	Warm White	83	350	3.0	2580 K	3250 K	130	U2/V1/V2*
	PQ2N-4LWE-WFC	White	70	350	3.0	4800 K	6450 K	130	W2/X1*/X2*
	PQ2N-4LNE-WFC	Neutral White	70	350	3.0	3710 K	4800 K	130	W2/X1*
	PQ2N-4LVE-WFCR8	Warm White	83	350	3.0	2580 K	3250 K	130	W1/W2*

Watt	Part No.	Color	Test Current (mA)	Vf (Typ.)	λ _D /λ _p (Min.)	λ _D /λ _p (Max.)	2θ _{1/2}	Bin Code
	PQ2A-4FRE	Red	350	2.15	613.5 nm	631 nm	130	Q/R/S1*
	PQ2A-4FGE	Green	350	3.10	515 nm	535 nm	130	T2/U1/U2/V1*
	PQ2A-4FCE	Cyan	350	3.10	495 nm	515 nm	130	S2/T1*
	PQ2A-4FBE	Blue	350	3.10	465 nm	485 nm	130	N/P/Q*
4	PQ2A-4FPE-RWFC	PC Red	350	3.00	615 nm	622 nm	130	M/N*
	PQ2A-4FPE-AFC	PC Amber	350	3.00	587.5 nm	592.5 nm	130	T1/T2/U1*
	PQ2A-4FPE-AWFC	PC Amber	350	3.00	587.5 nm	592.5 nm	130	T1/T2/U1*
	PQ2A-4FPE-YGFC	PC Yellow Green	350	3.00	566.0 nm	569.0 nm	130	V1/V2/W1*
	PQ2A-4FPE-YGWFC	PC Yellow Green	350	3.00	550 nm	553 nm	130	X1/X2*

Watt	Part No.	Color	Test Current (mA)	Vf (Typ.)	λ _D /λ _p (Min.)	λ _D /λ _p (Max.)	2θ _{1/2}	Bin Code
4	PQ2N-4LRE	Red	350	2.15	610 nm	631 nm	130	S1/S2/T1/T2/U1*
	PQ2N-4LGE	Green	350	3.10	515 nm	535 nm	130	U1*/U2/V1/V2/W1*/W2*
	PQ2N-4LCE	Cyan	350	3.10	495 nm	515 nm	130	T1/T2*
	PQ2N-4LBE	Blue	350	3.10	465 nm	485 nm	130	P/Q/R*
	PQ2N-4LBE-V	Blue	350	3.00	470 nm	477.5 nm	130	R/S1*
	PQ2N-4LDE	Royal Blue	350	3.10	450 nm	460 nm	130	Q/R*
	PQ2N-4LME	Crimson	350	2.15	650 nm	670 nm	130	P/Q*
	PQ2N-4LEE	Cherry Red	350	2.00	720 nm	740 nm	130	M/N*
	PQ2N-4LPE-AFC	PC Amber	350	3.00	587.5 nm	589.7 nm	130	T1/T2/U1*
	PQ2N-4LPE-AWFC	PC Amber	350	3.00	587.5 nm	592.5 nm	130	T2/U1/U2*
	PQ2N-4LPE-YGWFC	PC Yellow Green	350	3.00	566 nm	569 nm	130	W2/X1*/X2*

Bin Code- CSP1616 Photometric Luminous(lm)

	P	Q	R	S1	S2	T1	T2
min	23.5	30.6	39.8	50	60	70	80
max	30.6	39.8	51.7	60	70	80	90

	U1	U2	V1	V2	W1	W2	X1
min	90	100	110	120	130	140	155
max	100	110	120	130	140	155	170

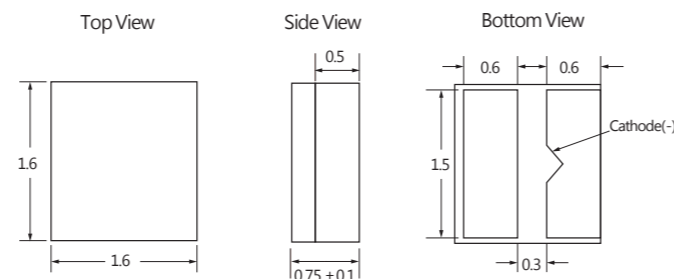

Bin Code- CSP1616 Radiometric Power (mW)

	M	N	P	Q	R	S
min	225	275	335	435	515	635
max	275	335	435	515	635	755

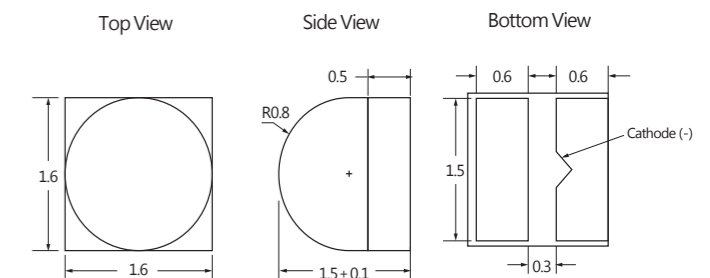

Tunable White COB

- Designed with dual-driven current-controlled channels.
- CCT can be changed from 2700K to 6500K while maintaining the same brightness.

Ceramic substrate

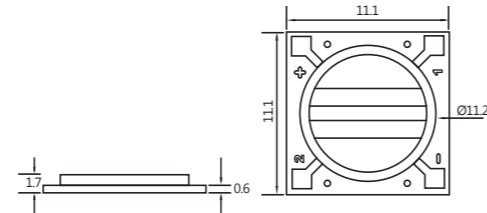
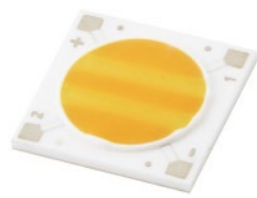

Part No.	CRI	Test Current (mA)	Vf (Typ.)	Lumens (Min.)	Lumens (Typ.)	CCT (Typ.)	2θ _{1/2}
PDSP-8FQL-D2748A	90	Channel 1 : 280	18	500	600	4800 K	120
		Channel 2 : 280	18	450	540	2700 K	
PDSP-8FQL-D2748	90	Channel 1 : 140	36	580	697	4800 K	120
		Channel 2 : 140	36	510	617	2700 K	

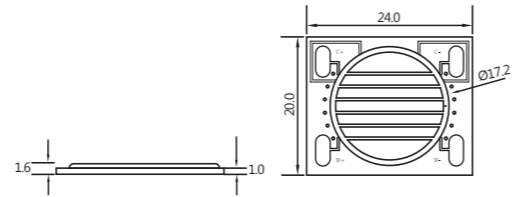

Part No.	CRI	Test Current (mA)	Vf (Typ.)	Lumens (Min.)	Lumens (Typ.)	CCT (Typ.)	2θ _{1/2}
PDSJ-15FQL-D2748	90	Channel 1 : 200	36	800	890	4800 K	120
		Channel 2 : 200	35	684	760	2700 K	
PDSJ-25FQL-D2748	90	Channel 1 : 450	37	1630	1800	4800 K	120
		Channel 2 : 450	36	1440	1650	2700 K	

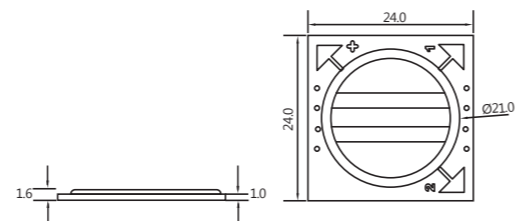
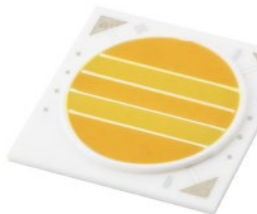

Part No.	CRI	Test Current (mA)	Vf (Typ.)	Lumens (Min.)	Lumens (Typ.)	CCT (Typ.)	2θ _{1/2}
PDRA-35FQL-D2748	90	Channel 1 : 850	36	3200	3700	4800 K	120
		Channel 2 : 850	35	2700	3200	2700 K	

Aluminum substrate

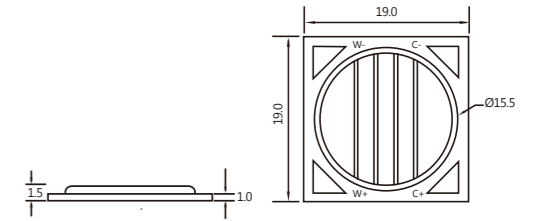
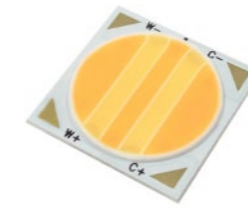

Part No.	CRI	Test Current (mA)	Vf (Typ.)	Lumens (Min.)	Lumens (Typ.)	CCT (Typ.)	2θ _{1/2}
PAPF-12FQL-D2750	90	Channel 1 : 350	36.5	1400	1562	5000 K	120
		Channel 2 : 350	36.5	1310	1454	2700 K	
PAPF-18FQL-D2750	90	Channel 1 : 500	37	1980	2200	5000 K	120
		Channel 2 : 500	35	1860	2070	2700 K	
PAPF-25FQL-D2750	90	Channel 1 : 700	36.5	2720	3020	5000 K	120
		Channel 2 : 700	36.5	2520	2800	2700 K	

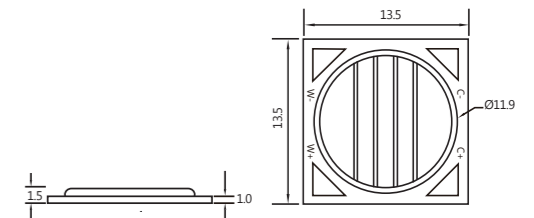

Part No.	CRI	Test Current (mA)	Vf (Typ.)	Lumens (Min.)	Lumens (Typ.)	CCT (Typ.)	2θ _{1/2}
PAPE-8FQL-D2750	90	Channel 1 : 250	37	900	1010	5000 K	120
		Channel 2 : 250	35	870	970	2700 K	

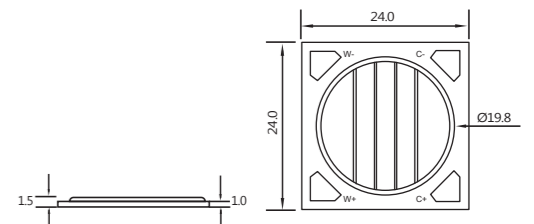
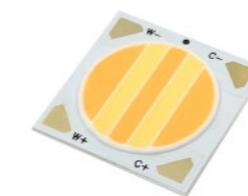

Part No.	CRI	Test Current (mA)	Vf (Typ.)	Lumens (Min.)	Lumens (Typ.)	CCT (Typ.)	2θ _{1/2}
PAPC-40FQL-D3050B	90	Channel 1 : 700	36	2930	3260	5000 K	120
		Channel 2 : 700	35	2870	3190	3000 K	

Aluminum substrate

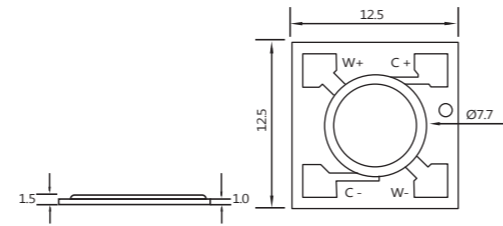
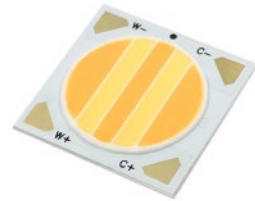

Part No.	CRI	Test Current (mA)	Vf (Typ.)	Lumens (Min.)	Lumens (Typ.)	CCT (Typ.)	2θ _{1/2}
PASV-6FQL-D2750	90	Channel 1 : 150	38	530	627	5000 K	120
		Channel 2 : 150	38	470	550	2700 K	

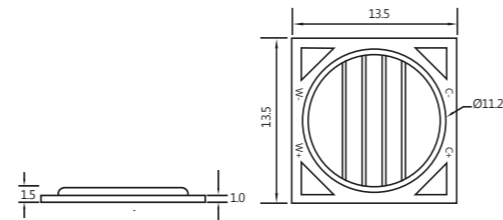
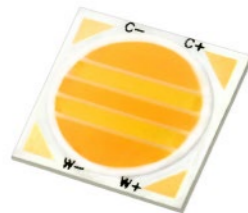

Part No.	CRI	Test Current (mA)	Vf (Typ.)	Lumens (Min.)	Lumens (Typ.)	CCT Typ.	2θ _{1/2}
PABP-12FQL-D2765	90	Channel 1 : 250	37	935	1040	6500 K	120
		Channel 2 : 250	36	910	1010	2700 K	

Warm on Dim COB

- Dimming to warm color temperatures as the best replacement for conventional halogen lamp.
- ProLight's own patent.
- 2-step MacAdam ellipse.

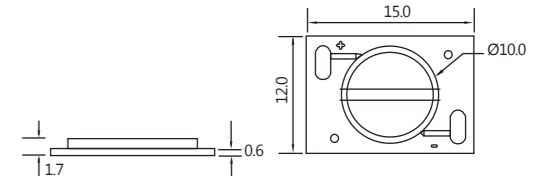
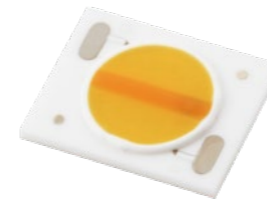

Part No.	CRI	Test Current (mA)	Vf (Typ.)	Lumens (Min.)	Lumens (Typ.)	CCT (Typ.)	2θ _{1/2}
PDSQ-6FVL-D1930	90	50	13.8	38	43	1900 K	120
		350	18.0	540	621	3000 K	
PDSQ-10FVL-D1927	90	50	13.8	38	45	1900 K	120
		350	18.0	540	605	2700 K	
PDSQ-10FVL-D1930	90	50	13.8	38	45	1900 K	120
		350	18.0	540	654	3000 K	
PDSQ-17FVL-D2030	90	50	31.0	110	120	2000 K	120
		350	37.0	1000	1100	3000 K	
PDSQ-17FVL-D2030A	90	50	31.0	110	120	2000 K	120
		350	37.0	1000	1100	3000 K	

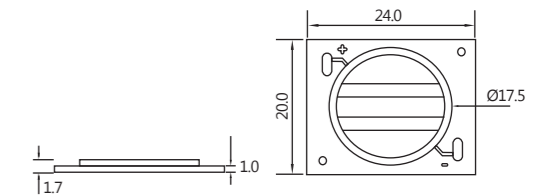

Part No.	CRI	Test Current (mA)	Vf (Typ.)	Lumens (Min.)	Lumens (Typ.)	CCT (Typ.)	2θ _{1/2}
PDSR-40FVL-D2030	90	80	29.0	180	200	2000 K	120
		950	36.0	2900	3300	3000 K	

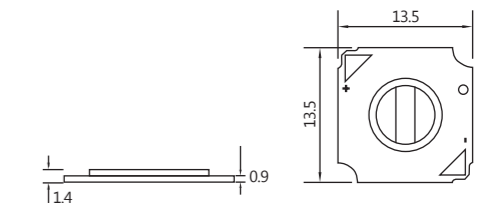

Part No.	CRI	Test Current (mA)	Vf (Typ.)	Lumens (Min.)	Lumens (Typ.)	CCT (Typ.)	2θ _{1/2}
PAPQ-6FVL-D2030	90	50	15.0	35	42	2000 K	120
		350	18.8	500	600	3000 K	

Brill-CRI 98

- CRI >97 suitable for commercial lighting.



Watt	Part No.	Color	CRI (Min.)	Test Current (mA)	Vf (Typ.)	Lumens (Min.)	Lumens (Typ.)	CCT (Typ.)	2θ _{1/2}
16	PASB-16FNL-EC2NS40	Neutral White	97	200	32.3	725	875	3985 K	120
	PASB-16FVL-EC2NS30	Warm White	97	200	32.3	700	840	3045 K 3040 K	120
	PASB-16FVL-EC2NS27	Warm White	97	200	32.2	680	820	2725 K	120

Brill-Full Spectrum

- ProLight Brill-Full Spectrum series can be used for all kind of lighting applications. Such as human centric lighting, commercial lighting.



Watt	Part No.	Color	CRI (Typ.)	Test Current (mA)	Vf (Typ.)	Lumens (Min.)	Lumens (Typ.)	CCT (Typ.)	2θ _{1/2}
16	PASB-16FNL-EC4NS40	Neutral White	97	200	32.3	675	810	3985 K	120
	PASB-16FVL-EC4NS30	Warm White	97	200	32.3	675	810	3045 K 3040 K	120
	PASB-16FVL-EC4NS27	Warm White	97	200	32.2	635	765	2725 K	120

Brill-Full Spectrum simulates solar spectrum.

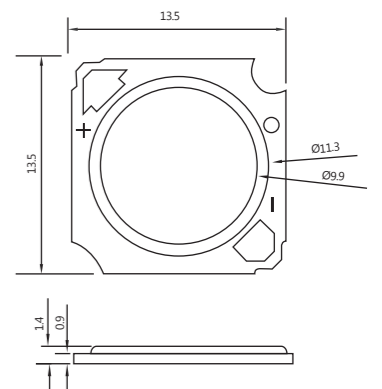
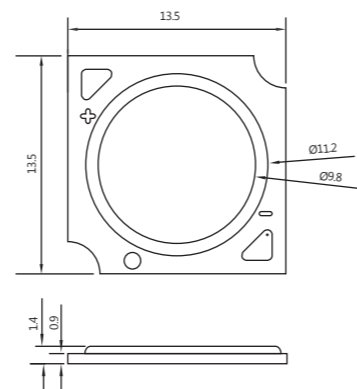
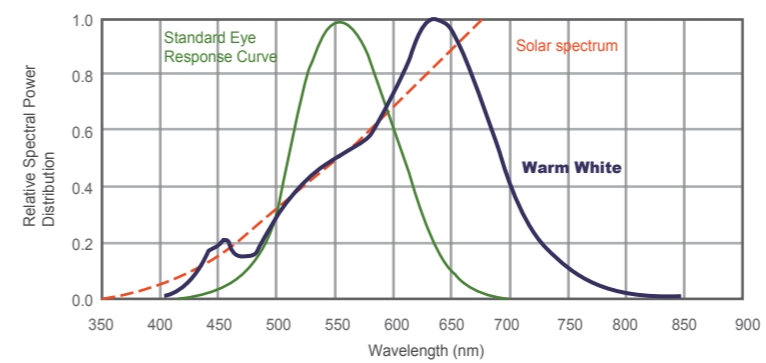
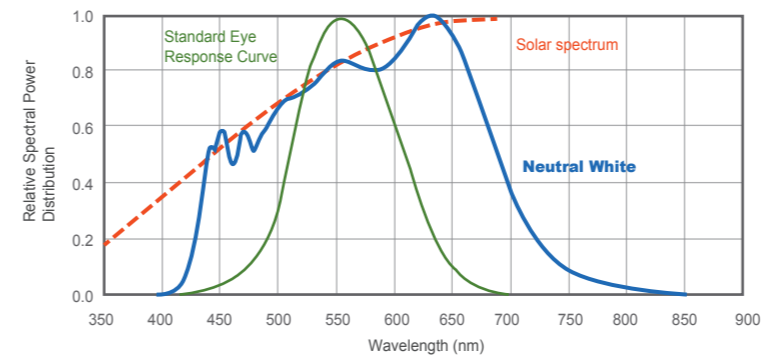

Phenix 3535

- Standard 3535 package with various color options.
- LM-80 passed.



size : 3.45 X 3.45 mm

Watt	Part No.	Color	CRI	Test Current (mA)	Vf (Typ.)	Lumens (Min.)	Lumens (Typ.)	λ_d / λ_p (Min.)	λ_d / λ_p (Max.)	Max Current (mA)	$2\theta_{1/2}$
3	PK2N-3LRE-SD	Red	-	350	2.2	50 lm	64 lm	613.5 nm	631 nm	700	130
	PK2N-3LAE-SD	Amber	-	350	2.2	50 lm	70 lm	587 nm	597 nm	700	130
	PK2N-3LGE-SD	Green	-	350	3.1	90 lm	150 lm	515 nm	535 nm	700	130
	PK2N-3LBE-SD	Blue	-	350	3.1	23.5 lm	29 lm	455 nm	475 nm	700	130
	PK2N-3LDE-SD	Royal Blue	-	350	3.1	515 mW	620 mW	450 nm	460 nm	700	130
	PK2N-3LME-SD	Crimson	-	350	2.2	275 mW	390 mW	650 nm	670 nm	700	130
	PK2N-3LEE-SD	Cherry Red	-	350	2.0	225 mW	300 mW	720 nm	740 nm	700	130
	PK2E-3LPE-ASD	PC Amber	-	350	3.2	80 lm	100 lm	587.8 nm	590.4 nm	700	130
	PK2E-3LPE-ASDR8	PC Amber	80	350	3.2	40 lm	55 lm	587.8 nm	590.4 nm	700	130
	PK2E-3LPE-J24	Warm White	72	350	3.2	100 lm	121 lm	2370 K	2470 K	700	130
	PK2E-3LPE-J21	2100 K	75	350	3.2	90 lm	108 lm	2090 K	2190 K	700	130
	PK2E-3LPE-YSD	PC Yellow	-	350	3.2	80 lm	89 lm	583 nm	585.4 nm	700	130
	PK2N-3LPE-YG	PC Yellow Green	-	350	3.2	140 lm	165 lm	566.0 nm	569.0 nm	700	130
4	PK2N-4JRE-SD	Red	-	350	2.15	50 lm	65 lm	620 nm	630 nm	1000	45
	PK2N-4JDE-SD	Royal Blue	-	350	3.1	515 mW	630 mW	450 nm	460 nm	1000	45
	PK2N-4LRE-SSD	Red	-	350	2.2	40 lm	55 lm	610 nm	630 nm	1000	130
	PK2N-4LGE-SSD	Green	-	350	3.3	110 lm	123 lm	525 nm	535 nm	1000	130
	PK2N-4LBE-SSD	Blue	-	350	2.95	23.5 lm	26 lm	455 nm	475 nm	1000	130
	PK2N-4LDE-SSD	Royal Blue	-	350	2.95	560 mW	640 mW	450 nm	460 nm	1000	130
	PK2N-4LPE-SASD	PC Amber	-	350	2.95	90 lm	112 lm	587.8 nm	590.4 nm	1000	130
5	PK2N-4LPE-SJ21	2100 K	-	350	2.95	100 lm	120 lm	2090 K	2190 K	1000	130
	PK2N-5LBE-MSD	Blue	-	350	3.2	39.8 lm	45 lm	470 nm	485 nm	1200	130
	PK2E-5LPE-ASD	PC Amber	-	350	3.05	90 lm	105 lm	587.8 nm	590.4 nm	1200	130
	PK2E-5LPE-J21	2100 K	-	350	3.05	100 lm	113 lm	2090 K	2190 K	1200	130
	PK2E-5LPE-M	PC Magenta	-	350	3.05	40 lm	45 lm	-	-	1200	130

Phenix 3030

- Standard 3030 package.
- Available with dome lens or flat emitting surface.



size : 3.0 X 3.0 mm

Watt	Part No.	Color	CRI	Test Current (mA)	Vf (Typ.)	Lumens (Min.)	Lumens (Typ.)	λ_d / λ_p (Min.)	λ_d / λ_p (Max.)	Max Current (mA)	$2\theta_{1/2}$
1	PW2R-1FRE-S	Red	-	350	2.5	32	45	620 nm	630 nm	-	120
	PW2E-1FGE-S	Green	-	350	3.2	60	75	515 nm	530 nm	-	120
	PW2E-1FBE-S	Blue	-	350	3.3	18.1	22	465 nm	475 nm	-	120
	PW2N-1FPE-A2SC	PC Amber	-	150	6.4	100	112	587.8 nm	590.4 nm	-	120
	PW2N-1FPE-A2SCC	PC Amber	-	150	6.4	25	31	606 nm	609 nm	-	120
	PW2N-1FPE-A2SCB	PC Amber	-	150	6.4	50	70	597 nm	606 nm	-	120
	PW2N-1FPE-A2	PC Amber	-	300	3.2	90	112	587.8 nm	591.2 nm	-	120
	PW2N-1FPE-J25A2SC	2500 K	70	150	6.4	120	132	2370 K	2640 K	-	120
	PW2N-1FPE-J21	2100 K	75	150	6.4	90	110	2090 K	2190 K	-	120
	PW2N-1FPE-B20B	2000 K	-	150	6.4	100	122	1920 K	2100 K	-	120
2	PW2N-2FPE-B2	PC Blue	-	350	3.1	60	70	465 nm	475 nm	-	120



size : 3.0 X 3.0 mm

Watt	Part No.	Color	CRI	Test Current (mA)	Vf (Typ.)	Lumens (Min.)	Lumens (Typ.)	λ_d / λ_p (Min.)	λ_d / λ_p (Max.)	Max Current (mA)	$2\theta_{1/2}$
1	PJ2N-1FPE-Y2SC	PC Yellow	-	150	6.4	110	120	580.9 nm	585.9 nm	400	130
	PJ2E-1FRE	Red	-	350	2.6	30	42	620 nm	630 nm	350	130
	PJ2E-1FGE	Green	-	350	3.6	50	65	515 nm	535 nm	350	130
	PJ2E-1FBE	Blue	-	350	3.6	10.7	15.5	455 nm	475 nm	350	130
2	PJ2E-2LPE-A2	PC Amber	-	350	3.1	110	120	587.8 nm	590.4 nm	600	130

NEW

10W 3535 LED

◆ The light-emitting-area of 1mm² can drive up to 10 watt.



size : 3.5 X 3.5 mm viewing angle : 120°

Watt	Part No.	Color	Test Current (mA)	Vf (Typ.)	Lumens (Min.)	Lumens (Typ.)	λ_d / λ_p (Min.)	λ_d / λ_p (Max.)	Max Current (mA)
10	PB2N-10FWE-SD	White	1000	3.0	284.5 lm	320 lm	6000 K	7200 K	3000
	PB2N-10FRE-SD	Red	1000	2.3	87.4 lm	100 lm	620 nm	630 nm	2500
	PB2N-10FGE-SD	Green	1000	3.4	168.4 lm	205 lm	520 nm	530 nm	3000
	PB2N-10FDE-SD	Royal Blue	1000	3.0	1050 mW	1300 mW	450 nm	460 nm	3000
	PB2N-10FPE-ASDA	PC Amber	1000	3.0	140 lm	180 lm	588 nm	592 nm	3000
	PB2N-10FPE-GSDA	PC Green	1000	3.0	330 lm	380 lm	566 nm	570 nm	3000

3-color in 1



size : 4.0 X 5.0 mm viewing angle : 140°

Watt	Part No.	Color	Test Current (mA)	Vf (Typ.)	Lumens (Min.)	Lumens (Typ.)	λ_d / λ_p (Min.)	λ_d / λ_p (Max.)
1	PP6N-1LFE-P	Red	150	2.2	23	28	620 nm	630 nm
		Green	150	3.3	38	45	525 nm	535 nm
		Blue	150	3.2	8	9.5	455 nm	460 nm
3	PP6N-3LFE	Red	350	2.3	44	52	620 nm	630 nm
		Green	350	3.3	69	81	520 nm	530 nm
		Blue	350	3.4	18	21	460 nm	465 nm

◆ 3030 package size is suitable for small size luminaries.



size : 3.0 X 3.0 mm viewing angle : 155°

Watt	Part No.	Color	Test Current (mA)	Vf (Typ.)	Lumens (Min.)	Lumens (Typ.)	λ_d / λ_p (Min.)	λ_d / λ_p (Max.)
3	PBLB-3LFE	Red	250	2.25	30	36	620 nm	630 nm
		Green	250	3.45	40	52	518 nm	528 nm
		Blue	250	3.30	8	11	453 nm	460 nm

NEW

4-color in 1

- Exclusive glue material can enhance reliability.
- Thermal shock test >1000 cycles.



size : 5.0 X 5.0 mm viewing angle : 115°

Watt	Part No.	Color	CRI	Test Current (mA)	Vf (Typ.)	Lumens (Min.)	Lumens (Typ.)	CCT/λd (Min.)	CCT/λd (Max.)
0.4	PE8A-FFTE-WED	Red	-	20	2.20	770 mcd	900 mcd	619 nm	624 nm
		Green	-	20	3.00	1550 mcd	1850 mcd	521 nm	526 nm
		Blue	-	20	3.00	330 mcd	400 mcd	465 nm	470 nm
		White	80	60	3.15	19 lm	21 lm	5640 K	6970 K
	PE8A-FFTE-WERGBND	Red	-	20	2.20	770 mcd	900 mcd	619 nm	624 nm
		Green	-	20	3.00	1550 mcd	1850 mcd	521 nm	526 nm
		Blue	-	20	3.00	330 mcd	400 mcd	465 nm	470 nm
		Neutral White	80	60	3.15	19 lm	21 lm	3700 K	4250 K
	PE8A-FFTE-WERGBVD	Red	-	20	2.20	770 mcd	900 mcd	619 nm	624 nm
		Green	-	20	3.00	1550 mcd	1850 mcd	521 nm	526 nm
		Blue	-	20	3.00	330 mcd	400 mcd	465 nm	470 nm
		Warm White	80	60	3.15	18 lm	20 lm	2850 K	3250 K



size : 3.0 X 3.0 mm viewing angle : 155°

- The smallest 4-in-1 LED in the industry.

Watt	Part No.	Color	CRI	Test Current (mA)	Vf (Typ.)	Lumens (Min.)	Lumens (Typ.)	CCT/λd (Min.)	CCT/λd (Max.)
2	PBLB-2FTE	Red	-	150	2.15	14	17	620 nm	630 nm
		Green	-	150	3.25	19	26	520 nm	530 nm
		Blue	-	150	3.15	5	6.6	453 nm	460 nm
		White	-	150	3.15	23	29	5700 K	7000 K
	PBLB-2FTE-RGBN	Red	-	150	2.15	14	17	620 nm	630 nm
		Green	-	150	3.25	19	26	520 nm	530 nm
		Blue	-	150	3.15	5	6.6	453 nm	460 nm
		Neutral White	80	150	3.15	19	25	3700 K	4250 K
	PBLB-2FTE-RGBV	Red	-	150	2.15	14	17	620 nm	630 nm
		Green	-	150	3.25	19	26	520 nm	530 nm
		Blue	-	150	3.15	5	6.6	453 nm	460 nm
		Warm White	80	150	3.15	18	23	2870 K	3220 K

ООО "СЭЛКОМ"
Поставка образцов и промышленных партий.
Тел: +7 (495) 204-13-84
E-mail: sale@radiodetali.com

- The smallest 4-in-1 LED in the industry.



size : 3.0 X 3.0 mm viewing angle : 155°

Watt	Part No.	Color	CRI	Test Current (mA)	Vf (Typ.)	Lumens (Min.)	Lumens (Typ.)	CCT/λd (Min.)	CCT/λd (Max.)	Max Current (mA)
3	PBLB-3LTE	Red	-	250	2.25	30	36	620 nm	630 nm	300
		Green	-	250	3.45	40	52	518 nm	528 nm	
		Blue	-	250	3.3	8	11	453 nm	460 nm	
		White	70	250	3.3	44	56	4480 K	6970 K	
	PBLB-3LTE-RGBN	Red	-	250	2.25	30	36	620 nm	630 nm	300
		Green	-	250	3.45	40	52	518 nm	528 nm	
		Blue	-	250	3.3	8	11	453 nm	460 nm	
		Neutral White	80	250	3.3	37.4	49	3700 K	4250 K	
	PBLB-3LTE-RGBV	Red	-	250	2.25	30	36	620 nm	630 nm	300
		Green	-	250	3.45	40	52	518 nm	528 nm	
		Blue	-	250	3.3	8	11	453 nm	460 nm	
		Warm White	80	250	3.3	34.1	46	2870 K	3220 K	
PBLB-3L4E-RGBPG	Red	-	250	2.25	30	36	620 nm	630 nm	300	
	Green	-	250	3.50	40	52	518 nm	528 nm		
	Blue	-	250	3.40	8	11	453 nm	460 nm		
	PC Green	-	250	3.40	44	56	562.6 nm	569.5 nm		
PBLB-3L4E-RGBP	Red	-	250	2.25	30	36	620 nm	630 nm	300	
	Green	-	250	3.45	40	52	518 nm	528 nm		
	Blue	-	250	3.30	8	11	453 nm	460 nm		
	PC Amber	-	250	3.30	15	18	592.5 nm	595.5 nm		
PBLB-5LTE	Red	-	350	2.30	45	55	619 nm	629 nm	400	
	Green	-	350	3.30	90	115	520 nm	530 nm		
	Blue	-	350	3.30	19	25	454 nm	461 nm		
	White	-	350	3.30	80	105	4480 K	6970 K		
PBLB-5LTE-RGBN	Red	-	350	2.30	45	55	619 nm	629 nm	400	
	Green	-	350	3.30	90	115	520 nm	530 nm		
	Blue	-	350	3.30	19	25	454 nm	461 nm		
	Neutral White	80	350	3.30	68	92	3700 K	4250 K		
PBLB-5LTE-RGBV	Red	-	350	2.30	45	55	619 nm	629 nm	400	
	Green	-	350	3.30	90	115	520 nm	530 nm		
	Blue	-	350	3.30	19	25	454 nm	461 nm		
	Warm White	80	350	3.30	62	86	2870 K	3220 K		

4-color in 1

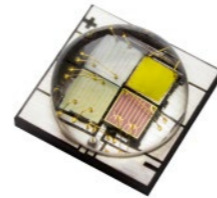

size : 3.0 X 3.0 mm viewing angle : 155°

Watt	Part No.	Color	CRI	Test Current (mA)	Vf (Typ.)	Lumens (Min.)	Lumens (Typ.)	CCT/λd (Min.)	CCT/λd (Max.)	Max Current (mA)
10	PBLA-10LTE-S	Red	-	350	2.20	48	56	622 nm	632 nm	700
		Green	-	350	3.00	104	120	522 nm	530 nm	
		Blue	-	350	3.05	19	22	455 nm	460 nm	
		White	-	350	2.95	114	130	5700 K	8230 K	
	PBLA-10LTE-SRGBN	Red	-	350	2.20	48	56	622 nm	632 nm	700
		Green	-	350	3.00	104	120	522 nm	530 nm	
		Blue	-	350	3.05	19	22	455 nm	460 nm	
		Neutral White	80	350	2.95	100	117	3810 K	4120 K	
	PBLA-10LTE-SRGBV	Red	-	350	2.20	48	56	622 nm	632 nm	700
		Green	-	350	3.00	104	120	522 nm	530 nm	
		Blue	-	350	3.05	19	22	455 nm	460 nm	
		Warm White	80	350	2.95	94	110	2930 K	3140 K	
PBLA-10L4E-SRGBP	Red	-	350	2.20	48	56	622 nm	632 nm	700	
	Green	-	350	3.00	104	120	522 nm	530 nm		
	Blue	-	350	3.05	19	22	455 nm	460 nm		
	PC Amber	-	350	2.95	48	60	581.8 nm	584.7 nm		
15 PBLA-15LTE-S	Red	-	700	2.40	105	115	622 nm	632 nm	1000	
	Green	-	700	3.30	165	190	522 nm	530 nm		
	Blue	-	700	3.40	35	40	454 nm	459 nm		
	White	-	700	3.10	210	230	5700 K	8230 K		

7-color in 1

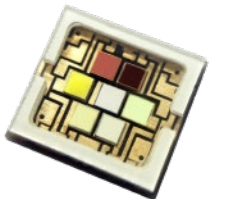

size : 6.7 X 6.25 mm viewing angle : 120°

- Wide color gamut design.
- The array of anode and cathode is easy to make series connection design.

Watt	Part No.	Color	Test Current (mA)	Vf (Typ.)	Lumens (Min.)	Lumens (Typ.)	CCT/λd (Min.)	CCT/λd (Max.)	Max Current (mA)
25	PBEF-25F7E-A	Red	700	2.4	65	79	620 nm	630 nm	1000
		Blue	700	3.2	26	34	453 nm	457 nm	
		PC Green	700	3.2	185	228	566 nm	570 nm	
		Purple	700	3.4	800 mW	1000 mW	392 nm	402 nm	
		White	700	3.2	175	200	5630 K	7030 K	
		Green	700	3.6	130	160	521 nm	527 nm	
	PBEF-25F7E-H	Amber	700	2.6	50	68	592 nm	597 nm	1500
		Red	700	2.4	65	79	620 nm	630 nm	
		Blue	700	3.2	26	34	453 nm	457 nm	
		Cyan	700	3.5	68	97	459 nm	505 nm	
		Purple	700	3.4	800 mW	1000 mW	392 nm	402 nm	
		White	700	3.2	175	200	5630 K	7030 K	
Green	700	3.6	130	160	521 nm	527 nm			
Amber	700	2.6	50	68	592 nm	597 nm			



size : 6.7 X 6.25 mm viewing angle : 120°

Watt	Part No.	Color	Test Current (mA)	Vf (Typ.)	Lumens (Min.)	Lumens (Typ.)	CCT/λd (Min.)	CCT/λd (Max.)	Max Current (mA)
15	PBEF-15F7E-A	Amber	350	2.2	38	45	586 nm	596 nm	700
		Green	350	2.8	56	70	525 nm	530 nm	
		Mint	350	2.8	77	85	562 nm	570 nm	
		Purple	350	3.3	360 mW	430 mW	397 nm	407 nm	
		White	350	2.8	76	90	5650 K	6960 K	
		Red	350	2.0	34	40	618 nm	628 nm	
		Blue	350	2.8	10	12	455 nm	460 nm	

Product features

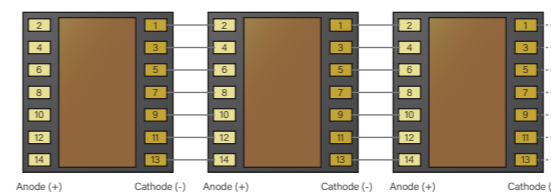

The array of anode and cathode is easy to make series connection design.

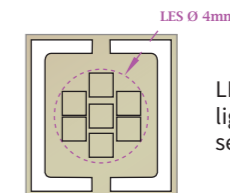

LES Ø 4mm, can be used with most light-guide rod in the market and make secondary optics design easily.

4-color in 1

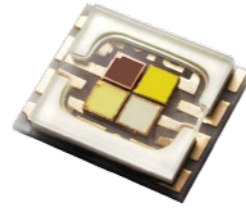

size : 5.7 X 4.7 mm viewing angle : 120°

Watt	Part No.	Color	CRI	Test Current (mA)	Vf (Typ.)	Lumens (Min.)	Lumens (Typ.)	CCT/λd (Min.)	CCT/λd (Max.)	Max Current (mA)
15	PBED-15FTE-S	Red	-	700	2.4	57	70	623 nm	633 nm	1000
		Green	-	700	3.6	140	160	521 nm	533 nm	
		Blue	-	700	3.1	800 mW	870 mW	453 nm	458 nm	
		White	-	700	3.1	175	225	5760 K	7250 K	
15	PBED-15F4E-A	Red	-	700	2.4	59	70	620 nm	630 nm	1000
		Green	-	700	3.5	140	170	525 nm	533 nm	
		Blue	-	700	3.3	760 mW	860 mW	453 nm	457 nm	
		Amber	-	700	2.5	56	70	589 nm	596 nm	
10	PBED-15F3E-VWVA01	Warm White	90	700	3.3	99	115	2620 K	2820 K	1000
		White	90	700	3.3	125	145	5210 K	6000 K	
		Warm White	90	700	3.3	99	115	2620 K	2820 K	
		Amber	-	700	2.5	56	70	589 nm	596 nm	
10	PBED-10FQE-WVWVR95	White	95	700	3.1	120	160	4780 K	5580 K	700
		Warm White	95	700	3.1	90	117	2790 K	3030 K	
		White	95	700	3.1	120	160	4780 K	5580 K	
		Warm White	95	700	3.1	90	117	2790 K	3030 K	
20	PBED-20FTE-S	Red	-	1000	2.6	100	120	620 nm	630 nm	1500
		Green	-	1000	3.2	205	245	520 nm	532 nm	
		Blue	-	1000	3.2	1100 mW	1200 mW	452 nm	457 nm	
		White	-	1000	3.2	280	315	5760 K	7250 K	
20	PBED-20FTE-SRGBV	Red	-	1000	2.6	100	120	620 nm	630 nm	1500
		Green	-	1000	3.2	205	245	519 nm	531 nm	
		Blue	-	1000	3.2	1100 mW	1200 mW	452 nm	457 nm	
		Warm White	-	1000	3.2	185	210	2930 K	3140 K	
20	PBED-20F4E-SRGBPG	Red	-	1000	2.6	100	120	620 nm	630 nm	1500
		Green	-	1000	3.2	205	245	520 nm	532 nm	
		Blue	-	1000	3.2	1100 mW	1200 mW	452 nm	457 nm	
		PC Green	-	1000	3.2	255	285	566 nm	570 nm	

4-color in 1

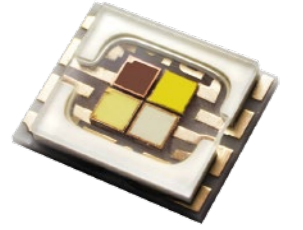



size : 5.7 X 4.7 mm viewing angle : 120°

Watt	Part No.	Color	CRI	Test Current (mA)	Vf (Typ.)	Lumens (Min.)	Lumens (Typ.)	CCT/λd (Min.)	CCT/λd (Max.)	Max Current (mA)
40	PBEE-40FTE	Red	-	1000	2.3	90	105	620 nm	630 nm	2500
		Blue	-	1000	3.0	1235 mW	1300 mW	450 nm	455 nm	
		Green	-	1000	3.4	195	225	519 nm	531 nm	
		White	-	1000	3.0	235	270	5760 K	7250 K	
40	PBEE-40F4E	Red	-	1000	2.3	90	105	620 nm	630 nm	2500
		Green	-	1000	3.0	1235 mW	1300 mW	450 nm	455 nm	
		Blue	-	1000	3.4	195	225	519 nm	531 nm	
		Amber	-	1000	3.0	140	153	588.5 nm	591.5 nm	
40	PBEE-40FVE-R9	Warm White	90	1000	3.0	135	160	2770 K	2970 K	2500
		Warm White	90	1000	3.0	135	160	2770 K	2970 K	
		Warm White	90	1000	3.0	135	160	2770 K	2970 K	
		Warm White	90	1000	3.0	135	160	2770 K	2970 K	

High power COB [Spot Light]

High power, high lumen density.



 6.1 X 6.1 mm

Watt	Part No.	Color	CRI	Test Current (mA)	Vf (Typ.)	Lumens (Min.)	Lumens (Typ.)	CCT (Typ.)
90	PU55-90FWL-N00C	White	72	1750	15.5	2300	2600	7250 K
				5000	18.5	5300	6000	7550 K



 Ø 7.9 mm

Watt	Part No.	Color	CRI	Test Current (mA)	Vf (Typ.)	Lumens (Min.)	Lumens (Typ.)	CCT (Typ.)
230	PBMM-230FWL-N01AH	White	70	1400	42.0	6750	7500	6950 K
				5000	47.4	16650	18500	7250 K 7550 K 7900 K



 Ø 6.4 mm

Watt	Part No.	Color	CRI	Test Current (mA)	Vf (Typ.)	Lumens (Min.)	Lumens (Typ.)	CCT (Typ.)
100	PBMM-100FWL-N01AG	White	70	3000	22	5400	6100	6950 K
				4500	23	7200	8100	7250 K
								7550 K 7900 K



 Ø 11.0 mm

Watt	Part No.	Color	CRI	Test Current (mA)	Vf (Typ.)	Lumens (Min.)	Lumens (Typ.)	CCT (Typ.)
450	PBMM-450FWL-N01AK	White	70	2800	42.6	13400	14560	6950 K
				10000	47.8	33300	37000	7250 K 7550 K 7900 K

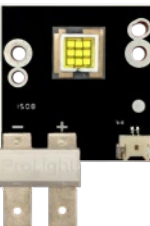

 Ø 7.6 mm

Watt	Part No.	Color	CRI	Test Current (mA)	Vf (Typ.)	Lumens (Min.)	Lumens (Typ.)	CCT (Typ.)
160	PBMM-160FWL-N01CC	White	70	1400	27.0	3300	380	7250 K
				5000	30.5	8200	9400	7550 K

High power COB [Effect Light]

Good color-mixing.

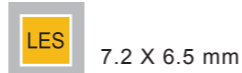

Watt	Part No.	Color	Test Current (mA)	Vf (Typ.)	Lumens (Min.)	Lumens (Typ.)	CCT (Min.)	CCT (Typ.)
60	PUMH-60FTL-N74N	Red	700	16.5	390	460	620 nm	630 nm
		Green	700	22.0	690	815	520 nm	528 nm
		Blue	700	21.0	140	165	453 nm	457 nm
		White	700	19.0	980	1160	5590 K	6500 K

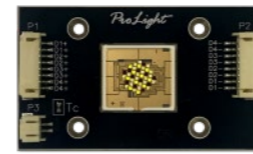

Watt	Part No.	Color	Test Current (mA)	Vf (Typ.)	Lumens (Min.)	Lumens (Typ.)	CCT (Min.)	CCT (Typ.)
230	PBMM-230F4L-N01AQ	Red	1000	29.5	1200	1600	620 nm	630 nm
		Green	1000	33.5	2100	2900	520 nm	530 nm
		Blue	1000	34.5	400	500	452 nm	457 nm
		PC Green	1000	34.5	2600	3100	566 nm	570 nm



Watt	Part No.	Color	Test Current (mA)	Vf (Typ.)	Lumens (Min.)	Lumens (Typ.)	CCT (Min.)	CCT (Typ.)
120	PUMG-120FTL-ND4N	Red	700	31	750	890	620 nm	630 nm
		Green	700	43	1450	1700	520 nm	528 nm
		Blue	700	41	280	330	453 nm	457 nm
		White	700	39	2050	2400	5590 K	6500 K



Watt	Part No.	Color	Test Current (mA)	Vf (Typ.)	Lumens (Min.)	Lumens (Typ.)	CCT (Min.)	CCT (Typ.)
350	PBMM-350FTL-N01AA	Red	2000	22.9	1400	1670	620 nm	630 nm
		Green	2000	31.4	2200	2600	520 nm	530 nm
		Blue	2000	29.6	410	490	452 nm	457 nm
		White	2000	29.6	3850	4560	5750 K	7250 K



Watt	Part No.	Color	Test Current (mA)	Vf (Typ.)	Lumens (Min.)	Lumens (Typ.)	CCT (Min.)	CCT (Typ.)
120	PUMG-120F4L-ND4P	Red	700	31	750	890	620 nm	630 nm
		Green	700	43	1450	1700	520 nm	528 nm
		Blue	700	41	280	330	453 nm	457 nm
		PC Amber	700	39	1250	1500	588 nm	590.5 nm



Watt	Part No.	Color	Test Current (mA)	Vf (Typ.)	Lumens (Min.)	Lumens (Typ.)	CCT (Min.)	CCT (Typ.)
450	PBMM-450F4L-N01AP	Red	2000	29.5	2400	3200	620 nm	630 nm
		Green	2000	33.5	4200	5800	520 nm	530 nm
		Blue	2000	34.5	800	1000	452 nm	457 nm
		PC Amber	2000	34.5	5200	6200	566 nm	570 nm



Watt	Part No.	Color	Test Current (mA)	Vf (Typ.)	Lumens (Min.)	Lumens (Typ.)	CCT (Min.)	CCT (Typ.)
180	PBMM-180FTL-N01CA	Red	1600	21.5	1300	1500	620 nm	630 nm
		Green	1600	30.0	2850	3300	518 nm	526 nm
		Blue	1600	29.0	470	550	453 nm	458 nm
		White	1600	29.0	3450	4000	5750 K	7250 K

High power 6-color in 1 COB [Studio Light]

Dimable CCT 2200K-8000K.

CRI >97 which is suitable for studio or theatre.



Watt	Part No.	Color	Test Current (mA)	Vf (Typ.)	Lumens (Min.)	Lumens (Typ.)	CCT (Min.)	CCT (Max.)
200	PBMM-200F6L-N01AE	PC Amber	1600	30.5	2900	3300	588 nm	592 nm
		PC Green	1600	30.5	4400	5000	566 nm	570 nm
		Red	800	25.0	780	900	620 nm	630 nm
		Green	800	35.0	1700	2000	521 nm	528 nm
		Cyan	800	34.5	950	1100	486 nm	492 nm
		Blue	800	30.5	330	380	451 nm	456 nm



NEW



Watt	Part No.	Color	Test Current (mA)	Vf (Typ.)	Lumens (Min.)	Lumens (Typ.)	CCT (Min.)	CCT (Max.)
400	PBMM-400F6L-N01AE	PC Amber	3000	32.5	4500	5100	588 nm	592 nm
		PC Green	3000	32.5	7100	8100	566 nm	570 nm
		Red	1500	30.0	1400	1600	620 nm	630 nm
		Green	1500	38.0	2600	3000	522 nm	529 nm
		Cyan	1500	38.0	1400	1600	486 nm	492 nm
		Blue	1500	32.5	600	700	451 nm	456 nm



NEW



Watt	Part No.	Color	Test Current (mA)	Vf (Typ.)	Lumens (Min.)	Lumens (Typ.)	CCT (Min.)	CCT (Max.)
800	PBMM-700F6L-N01BN	PC Amber	3000	35.5	11000	13000	588 nm	592 nm
		PC Green	3000	35.5	18800	22200	566 nm	570 nm
		Red	1500	42.0	4600	5400	620 nm	630 nm
		Green	1500	32.0	6000	7100	522 nm	528 nm
		Cyan	1500	42.0	3400	4000	482 nm	492 nm
		Blue	1500	35.5	1100	1300	449nm	453 nm



Studio Lighting

CCT 2200K-8000K

CRI >97



Headlamp

● Pro-CSP adopts the evolutionary new phosphor film technology which provide better light uniformity and reliability.
All series passed AEC-Q101 test.

Watt	Part No.	Color	Test Current(mA)		Vf (Typ.)	Lumens (Min.)	Lumens (Typ.)	CCT (Typ.)	2θ _{1/2}
			Max Current(mA)						
7	PBVB-7FWU-F2G	White	1000	6.5	600	700	5620 K	120	
			1500	6.8	780	930	5880 K 6150 K 6450 K		
10	PBVC-10FWU-F3G	White	1000	9.7	900	1100	5620 K	120	
			1500	10.2	1160	1450	5880 K 6150 K 6450 K		
14	PBVD-14FWU-F4G	White	1000	9.7	1100	1400	5620 K	120	
			1500	10.2	1480	1850	5880 K 6150 K 6450 K		
17	PBVE-17FWU-F5G	White	1000	16.2	1600	1950	5620 K	120	
			1500	17.0	2060	2580	5880 K 6150 K 6450 K		
31	PBVF-31FWU-F9G	White	1000	30.1	2750	3200	5620 K	120	
			1500	31.0	3650	4250	5880 K 6150 K 6450 K		

Watt	Part No.	Color	Test Current(mA)		Vf (Typ.)	Lumens (Min.)	Lumens (Typ.)	CCT (Typ.)	2θ _{1/2}
			Max Current(mA)						
4	PBVA-4FWE-F1G	White	1000	3.2	300	390	5620 K	120	
			1200	3.3	360	450	5880 K 6150 K 6450 K		
7	PBVB-7FWE-F2G	White	1000	6.5	600	700	5620 K	120	
			1200	6.6	680	805	5880 K 6150 K 6450 K		
10	PBVC-10FWE-F3G	White	1000	9.7	900	1100	5620 K	120	
			1200	9.9	1000	1250	5880 K 6150 K 6450 K		
14	PBVD-14FWE-F4G	White	1000	12.9	1100	1400	5620 K	120	
			1200	13.1	1300	1600	5880 K 6150 K 6450 K		
17	PBVE-17FWE-F5G	White	1000	16.2	1600	1950	5620 K	120	
			1200	16.5	1800	2240	5880 K 6150 K 6450 K		
12	PBSC-12FWE-H3G	White	1000	9.7	1250	1720	5620 K	120	
			1500	10.2	1300	1790	5880 K 6150 K 6450 K		

NEW

Emitter

● Applications: rear light / signal light / braking light /DRL



size : 3.0 X 3.0 mm

Part No.	Color	Test Current (mA)	Vf (Typ.)	Lumens (Min.)	Lumens (Typ.)	CCT (Typ.)	2θ _{1/2}
AJ2N-WA1DF-2	White	150	3.2	55	65	5850 K	120
AJ2N-PA1DF-A	PC Amber	150	3.2	50	55	589 nm	120
AJ2N-RA1DF	Red	150	2.2	18.1	20	623 nm	120
AJ2N-GA1DF	Green	150	3.2	30.6	35	525 nm	120
AJ2N-BA1DF	Blue	150	3.2	6.3	9.0	465 nm	120
PJ2N-2FPE-A2	PC Amber	350	3.1	90	120	-	120

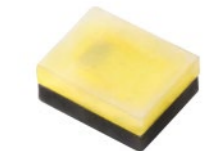

size : 2.0 X 1.6 mm

Part No.	Color	Test Current (mA)	Vf (Typ.)	Lumens (Min.)	Lumens (Typ.)	CCT (Typ.)	2θ _{1/2}
AF2N-WA1JF-2	White	1000	3.5	200	250	5610 K 5850 K 6100 K 6370 K 6650 K	120
AF2N-PA1JF-A	PC Amber	1000	3.5	160	200	-	120



size : 2.0 X 1.6 mm

Part No.	Color	Test Current (mA)	Vf (Typ.)	Lumens (Min.)	Lumens (Typ.)	CCT (Typ.)	2θ _{1/2}
AV2N-WA1AF-1	White	50	3.2	13.9	20	5850 K	120
AV2N-AA1AF-A	PC Amber	50	3.2	13.9	15.8	589 nm	120

Warming Light

● Good color uniformity and high brightness.



size : 3.0 X 3.0 mm



size : 3.0 X 3.0 mm



size : 3.45X 3.45 mm

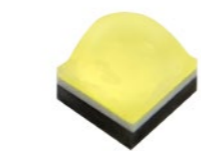

size : 1.6X 1.6 mm

Part No.	Color	Test Current (mA)	Vf (Typ.)	Lumens (Min.)	Lumens (Typ.)	CCT (Typ.)	2θ _{1/2}
PJ2E-1FRE	Red	150	2.60	30	42	623 nm	120
PJ2E-1FGE	Green	150	3.60	50	65	525 nm	120
PJ2E-1FBE	Blue	150	3.60	10.7	15.5	465 nm	120
PJ2E-2LPE-A2	PC Amber	350	3.10	110	120	589 nm	130

Part No.	Color	Test Current (mA)	Vf (Typ.)	Lumens (Min.)	Lumens (Typ.)	CCT (Typ.)	2θ _{1/2}
PW2N-1FPE-A2	PC Amber	300	3.20	90	112	590 nm	120
PW2N-2FPE-B	PC Blue	350	3.10	30	45	470 nm	120
PW2E-2FPE-B2	PC Blue	350	3.10	60	70	470 nm	120

Part No.	Color	Test Current (mA)	Vf (Typ.)	Lumens (Min.)	Lumens (Typ.)	CCT (Typ.)	2θ _{1/2}
PK2E-2LWE-B2R7S	White	350	3.05	160	175	6000K	130
PK2N-4LBE-MVSD	Blue	350	3.00	39.5	47	477.5 nm	130
PK2N-5LBE-MSD	Blue	350	3.20	39.8	45	480 nm	130

Part No.	Color	Test Current (mA)	Vf (Typ.)	Lumens (Min.)	Lumens (Typ.)	CCT (Typ.)	2θ _{1/2}
PQ2N-4LWE-WFC	White	350	3.00	140	148	5600 K	130
PQ2N-4LNE-WFC	Neutral White	350	3.00	140	148	4255 K	130
PQ2N-4LVE-WFCR8	Warm White	350	3.00	130	138	2900 K	130
PQ2N-4LPE-AWFC	PC Amber	350	3.00	80	95	589.7 nm	130
PQ2N-4LBE-V	Blue	350	3.00	39.8	47	477.5 nm	130
PQ2N-4LRE	Red	350	2.15	50	65	620.5 nm	130
PQ2N-4LGE	Green	350	3.10	90	130	525 nm	130



UVA 3535

- Quartz Lens, high UV penetration
- 3535 package comes in 3W / 5W / 8W with 30° viewing angle to deliver more focus radiometric power.
- Suitable for long-distance UV curing / UV printing applications.

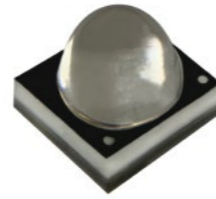

size : 3.5 x 3.5 mm

Watt	Part No.	Color	Test Current (mA)	Vf (Typ.)	Radiometric Power (Typ.mW)	λ_p (Typ.)	$2\theta_{1/2}$	Max Current (mA)
3	PB2D-3JLA-GS	■ UVA	700	3.70	930	365 nm	30	1000
	PB2D-3JLA-GM	■ UVA	700	3.50	1030	385 nm	30	1000
	PB2D-3JLA-G	■ UVA	700	3.50	1030	395 nm	30	1000
5	PB2D-5JLA-US	■ UVA	700	3.60	870	365 nm	30	1500
	PB2D-5JLA-UM	■ UVA	700	3.55	1150	385 nm	30	1500
	PB2D-5JLA-U	■ UVA	700	3.55	1150	395 nm	30	1500
8	PB2D-8JLA-US	■ UVA	700	3.70	930	365 nm	30	2500
	PB2D-8JLA-UM	■ UVA	700	3.50	1150	385 nm	30	2500
	PB2D-8JLA-U	■ UVA	700	3.50	1150	395 nm	30	2500

- Quartz Lens, high UV penetration
- 3535 package comes in 3W / 5W with 60° viewing angle
- Suitable for mid-distance UV curing / UV printing applications.

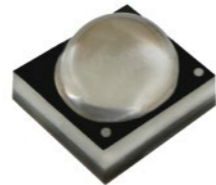

size : 3.5 x 3.5 mm

Watt	Part No.	Color	Test Current (mA)	Vf (Typ.)	Radiometric Power (Typ.mW)	λ_p (Typ.)	$2\theta_{1/2}$	Max Current (mA)
3	PB2D-3KLA-GS	■ UVA	700	3.70	950	365 nm	60	1000
	PB2D-3KLA-GM	■ UVA	700	3.50	1050	385 nm	60	1000
	PB2D-3KLA-G	■ UVA	700	3.50	1050	395 nm	60	1000
	PB2D-3KLA-GL	■ UVA	700	3.50	1050	405 nm	60	1000
5	PB2D-5KLA-US	■ UVA	700	3.60	870	365 nm	60	1500
	PB2D-5KLA-UM	■ UVA	700	3.55	1150	385 nm	60	1500
	PB2D-5KLA-U	■ UVA	700	3.55	1150	395 nm	60	1500

UVA 5050

- Quartz Lens, high UV penetration.
- 5050 package with 60° viewing angle, it is the highest illuminance (lux) in the industry.
- The best choice for short-distance curing.

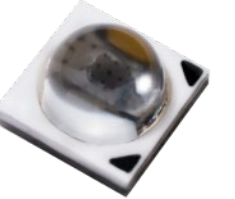

size : 5.0 x 5.0 mm

Watt	Part No.	Color	Test Current (mA)	Vf (Typ.)	Radiometric Power (Typ.mW)	λ_p (Typ.)	$2\theta_{1/2}$	Max Current (mA)
10	PBRD-10KLA-GS	■ UVA	1000	7.4	2800	365 nm	60	1400
	PBRD-10KLA-M	■ UVA	1000	6.8	2900	385 nm	60	1400
	PBRD-10KLA	■ UVA	1000	6.8	3100	395 nm	60	1400

ООО "СЭЛКОМ"
Поставка образцов и промышленных партий.

Тел: +7 (495) 204-13-84

E-mail: sale@radiodetaili.com

UVA series

UVA 7070

- Quartz Lens, high UV penetration.
- The footprint of 7070 package is compatible with 6868 package, which allow no design change on the PCB. 7070 package can deliver higher illuminance (lux).



size : 7.0 x 7.0 mm

Watt	Part No.	Color	Test Current (mA)	Vf (Typ.)	Radiometric Power (Typ.mW)	λ_p (Typ.)	$2\theta_{1/2}$	Max Current (mA)
10	PBSD-10JLA-GS	■ UVA	1000	7.4	2900	365 nm	48	1400
	PBSD-10JLA-M	■ UVA	1000	6.8	3000	385 nm	48	1400
	PBSD-10JLA	■ UVA	1000	6.8	3200	395 nm	48	1400
	PBSD-10KLA-GS	■ UVA	1000	7.4	3000	365 nm	60	1400
	PBSD-10KLA-M	■ UVA	1000	6.8	3100	385 nm	60	1400
	PBSD-10KLA	■ UVA	1000	6.8	3300	395 nm	60	1400

UVA 3535 Silicon Lens

- Silicon Lens UVA LED, suitable for UV exposure / UV curing.



size : 3.45 x 3.45 mm

Watt	Part No.	Color	Test Current (mA)	Vf (Typ.)	Radiometric Power (Typ.mW)	λ_p (Typ.)	$2\theta_{1/2}$	Max Current (mA)
3	PK2B-3JLE-NVM	■ UVA	500	3.4	1000	385 nm	60	700
	PK2B-3JLE-NV	■ UVA	500	3.4	1050	395 nm	60	700
	PK2B-3LLE-NVM	■ UVA	500	3.4	1000	385 nm	130	700
	PK2B-3LLE-PNV	■ UVA	500	3.4	1050	395 nm	130	700

- Quartz Lens, high UV penetration.
- Integrate 4 kinds of UVA wavelength in a 7070 package, to provide full range of UV curing.



size : 7.0 x 7.0 mm

Watt	Part No.	Color	Test Current (mA)	Vf (Typ.)	Radiometric Power (Typ.mW)	λ_p (Typ.)	$2\theta_{1/2}$	Max Current (mA)
10	PBSD-10JQA-GSMVL	■ UVA	500	13.9	3400	365+385+395+405nm	48	700
	PBSD-10KQA-GSMVL	■ UVA	500	13.9	3550	365+385+395+405nm	60	700

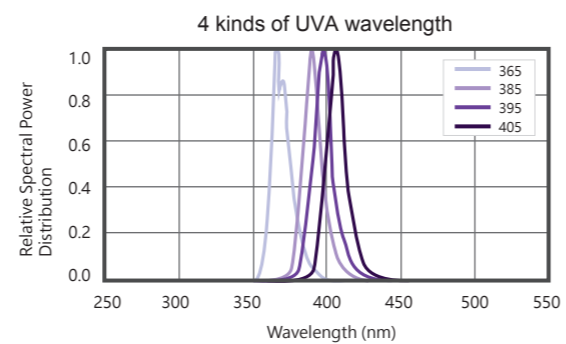

UVA 3535 module

- 3535 LED quartz lens module with narrow angle design to deliver more focus radiometric power.
- Suitable for long-distance UV printing / UV curing application.
- Seamless substrate design to keep illuminance (lux) uniformity.

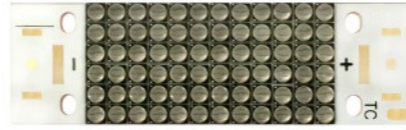

Watt	Part No.	Color	Test Current (mA)	Vf (Typ.)	Radiometric Power (Typ.W)	λ_p (Typ.)	$2\theta_{1/2}$
200	PB2M-3JLU-GDA72A0S	■ UVA	4200	46.8	67.0	365-370 nm	35
	PB2M-3JLU-DA72A0M	■ UVA	4200	42.0	68.4	385-390 nm	35
	PB2M-3JLU-DA72A0	■ UVA	4200	42.0	68.4	390-395 nm	35

UVA 5050 module

- 5050 package with 60° viewing angle, it is the highest illuminance (lux) in the industry.
- The best choice for short-distance curing.
- Seamless substrate design to keep illuminance (lux) uniformity.

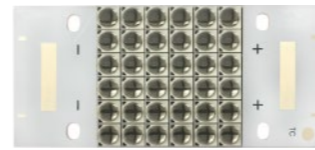

Watt	Part No.	Color	Test Current (mA)	Vf (Typ.)	Radiometric Power (Typ.W)	λ_p (Typ.)	$2\theta_{1/2}$
400	PBRM-10KLU-GDA36A0S	■ UVA	6000	44.4	100.0	365-370 nm	60
	PBRM-10KLU-GDA36A0M	■ UVA	6000	40.8	104.0	380-390 nm	60
	PBRM-10KLU-GDA36A0	■ UVA	6000	40.8	111.5	390-400 nm	60

UVA 7070 module

- 7070 LED quartz lens module.
- Suitable for UV printing / UV curing application.
- Seamless substrate design to keep illuminance (lux) uniformity.

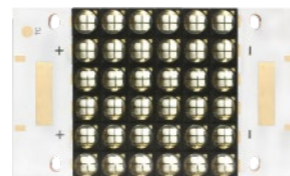

Watt	Part No.	Color	Test Current (mA)	Vf (Typ.)	Radiometric Power (Typ.W)	λ_p (Typ.)	$2\theta_{1/2}$
400	PBSM-10JLU-DA36A0M	■ UVA	6000	40.8	104.0	380-390 nm	60
	PBSM-10JLU-DA36A0	■ UVA	6000	40.8	111.5	390-400 nm	60

UVA COB

- AlN ceramic substrate with good heat dissipation.
- Plug and play with connector design.
- Seamless substrate design to keep illuminance (lux) uniformity.
- 30° viewing angle design to deliver more focus radiometric power.

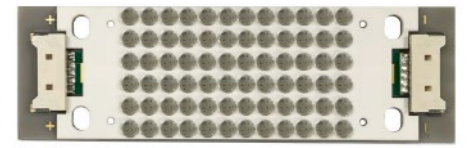

Watt	Part No.	Color	Test Current (mA)	Vf (Typ. W)	Radiometric Power (Typ.W)	λ_p (Typ.)	$2\theta_{1/2}$
200	PBCD-200JLK-GDA72A1S	■ UVA	4200	44.4	66.9	365-370 nm	30
	PBCD-200JLK-GDA72A1M	■ UVA	4200	42.0	74.2	385-390 nm	30
	PBCD-200JLK-GDA72A1	■ UVA	4200	42.0	74.2	390-400 nm	30

- AlN ceramic substrate with good heat dissipation. Plug and play with connector design.
- Thermal sensor and Surge protection device design can monitor thermal change to improve reliability and lifetime.
- Seamless substrate design to keep illuminance (lux) uniformity.



Watt	Part No.	Color	Test Current (mA)	Vf (Typ. W)	Radiometric Power (Typ.W)	λ_p (Typ.)	$2\theta_{1/2}$
300	PBDA-300FLD-NQ5S	■ UVA	3500	88.8	151	365-370 nm	120
	PBDA-300FLD-NQ5M	■ UVA	3500	84.0	160	385-390 nm	120
	PBDA-300FLD-NQ5	■ UVA	3500	84.0	160	390-400 nm	120

UVB series

UVB

- Narrow band of UVB, suitable for Phototherapy.
- Phototherapy (UVB 311nm) can cure skin immune disease, such as Psoriasis, Atopic dermatitis, Vitiligo.

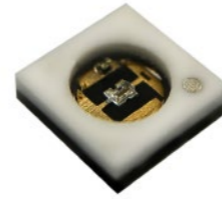

size : 3.5 x 3.5 mm

Watt	Part No.	Color	Test Current (mA)	Vf (Typ.)	Radiometric Power (Typ.mW)	λ_p (min-max.)	$2\theta_{1/2}$
0.2	PB2D-UCLA-KB	■ UVB	20	6.0	3.3	303-315 nm	120

UVC +UVA

- **Nano-quartz coating to deliver high UVC penetration.**
- Nano quartz covering technology to deliver high UV light transmittance.
- Integrating UVA and UVC into one package, where UVC and UVA can be controlled separately. When activate UVC, it can achieve short-term sterilization and UVA can be used as a warning light when UVC is turned on. Also, UVA can operate independently and can be light up for longer hours to have longer sterilization effect.



size : 3.0 x 3.0 mm

Watt	Part No.	Color	Test Current (mA)	Vf (Typ.)	Radiometric Power (Typ.mW)	λ_p (min-max.)	$2\theta_{1/2}$
1	PBLB-1CQA-TCL	■ UVC	20	6.8	2.5	265-280 nm	120
		■ UVA	20	3.2	13	400-410 nm	120



- **Quartz Lens**
- UVC+UVA dual-wavelength design. UVC / UVA can be controlled individually.

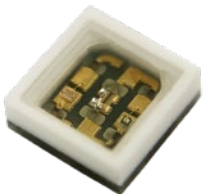

size : 3.5 x 3.5 mm

Watt	Part No.	Color	Test Current (mA)	Vf (Typ.)	Radiometric Power (Typ.mW)	λ_p (min-max.)	$2\theta_{1/2}$
1	PB4D-1FQA-TCL	■ UVC	20	6.8	2.5	265-280 nm	120
		■ UVA	20	3.2	13	400-410 nm	120

UVC 3535



- UVC flip chip with Nano-quartz coating and its transmittance rate >99% to improve sterilization efficiency.
- Nano-quartz coating can block water vapor, humidity and air to improve reliability.

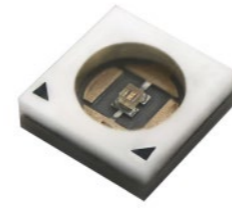

size : 3.5 x 3.5 mm

Watt	Part No.	Color	Test Current (mA)	Vf (Typ.)	Radiometric Power (Typ.mW)	λ_p (min-max.)	$2\theta_{1/2}$
0.2	PB2D-UCLA-TC	■ UVC	20	6.8	3.5	265-280 nm	120
1	PB2D-1CLA-TC	■ UVC	100	6.8	10.5	265-280 nm	120

UVC 5050



- UVC flip chip with Nano-quartz coating and its transmittance rate >99% to improve sterilization efficiency.
- Nano-quartz coating can block water vapor, humidity and air to improve reliability.
- **32mW high radiometric power!**

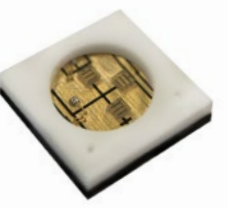

size : 5.0 x 5.0 mm

Watt	Part No.	Color	Test Current (mA)	Vf (Typ.)	Radiometric Power (Typ.mW)	λ_p (min-max.)	$2\theta_{1/2}$
3	PBLA-3CLA-TC	■ UVC	100	20	32	265-280 nm	120



- UVC flip chip with inorganic adhesive material to provide high reliability.
- 30° viewing angle with Germany high purity quartz lens to deliver more focus radiometric power.

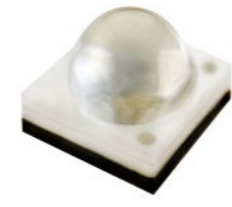

size : 3.5 x 3.5 mm

Watt	Part No.	Color	Test Current (mA)	Vf (Typ.)	Radiometric Power (Typ.mW)	λ_p (min-max.)	$2\theta_{1/2}$
0.2	PB2D-UJLA-TC	■ UVC	20	6.8	3.0	265-280 nm	30
1	PB2D-1JLA-TC	■ UVC	100	6.8	10.0	265-280 nm	30



- UVC flip chip with inorganic adhesive material to provide high reliability. AIN ceramic substrate with good heat dissipation.
- 30° viewing angle with Germany high purity quartz lens to deliver more focus radiometric power.
- **30mW high radiometric power!**

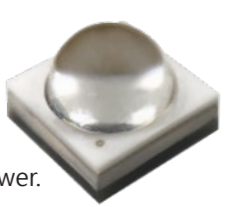

size : 5.0 x 5.0 mm

Watt	Part No.	Color	Test Current (mA)	Vf (Typ.)	Radiometric Power (Typ.mW)	λ_p (min-max.)	$2\theta_{1/2}$
3	PBLA-3KLA-TC	■ UVC	100	20	30	265-280 nm	60

UVC series

UVC 7070



- UVC flip chip with inorganic adhesive material to provide high reliability.
- 48° / 60° viewing angel with Germany extreme purity quartz lens to deliver more focus radiometric power.
- 100mW high power can be used for water / air sterilization.



size : 7.0 x 7.0 mm

Watt	Part No.	Color	Test Current (mA)	Vf (Typ.)	Radiometric Power (Typ.mW)	λ_p (min-max.)	$2\theta_{1/2}$
12	PBSD-12JLA-TC	■ UVC	400	21	100	265-280 nm	48
	PBSD-12KLA-TC	■ UVC	400	21	100	265-280 nm	60

UVC 5050 Module



- This UVC LED module is made of PBLA-3CLA-TC, radiometric power up to 1000mW.
- Nano-quartz coating can block water vapor, humidity and air to improve reliability.
- Seamless substrate design to keep illuminance (lux) uniformity.
- 1000mW high power can be used for water / air sterilization.

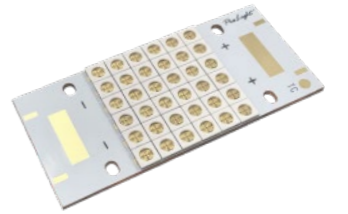

Watt	Part No.	Color	Test Current (mA)	Vf (Typ.)	Radiometric Power (Typ.mW)	λ_p (min-max.)	$2\theta_{1/2}$
100	PBLM-3CLU-TDA36A0C	■ UVC	600	120	1020	265-280 nm	120

UVC 1616



- UVC flip chip with Nano-quartz coating and its transmittance rate >99% to improve sterilization efficiency.
- Nano-quartz coating can block water vapor, humidity and air to improve reliability.

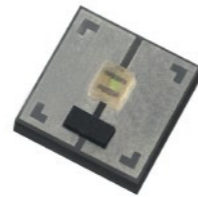

size : 1.6 x 1.60 mm

Watt	Part No.	Color	Test Current (mA)	Vf (Typ.)	Radiometric Power (Typ.mW)	λ_p (min-max.)	$2\theta_{1/2}$
0.2	PQ2A-UCLA-TC	■ UVC	20	6.8	3.5	265-280 nm	130

3535 package

- Standard 3535 package.
- High PPF.

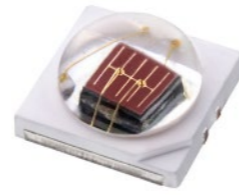

size : 3.45 X 3.45 mm

Watt	Part No.	Color	Test Current (mA)	Vf (Typ.)	Radiometric Power (Typ.mW)	PPF (umol/s)	PPF/W (umol/J)	λ_D/λ_P (Min.)	λ_D/λ_P (Max.)	$2\theta_{1/2}$
3	PK2N-3LDE-HSD	Royal Blue	350	2.90	745	2.77	2.67	448 nm	458 nm	130
	PK2N-3LME-HSD	Crimson	350	2.05	470	2.56	3.55	650 nm	670 nm	130
	PK2N-3LEE-HSD	Cherry Red	350	2.10	395	2.37	3.09	720 nm	740 nm	130
4	PK2N-4LME-HSDL	Crimson	700	2.15	1000	5.17	3.44	650 nm	670 nm	140

3030 package

- Standard 3535 package.
- High PPF.

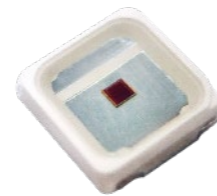

size : 3.0 X 3.0 mm

Watt	Part No.	Color	Test Current (mA)	Vf (Typ.)	Radiometric Power (Typ.mW)	PPF (umol/s)	PPF/W (umol/J)	λ_D/λ_P (Min.)	λ_D/λ_P (Max.)	$2\theta_{1/2}$
0.5	PW2R-FFDE	Royal Blue	150	3.2	250	0.93	1.94	450 nm	460 nm	120
	PW2R-FFME	Crimson	150	2.1	138	0.75	2.38	650 nm	670 nm	120
	PW2R-FFEE	Cherry Red	150	2.1	115	0.69	2.19	720 nm	740 nm	120

IR LED

- Standard 3535 package with various viewing angle.
- Suitable for all kind of IR applications.



size : 3.45 X 3.45 mm

$2\theta_{1/2}$	Part No.	Color	Test Current (mA)	Vf (Typ.)	Radiometric Power (Typ.mW)	mW/sf (typ.)	λ_p (Typ.)
80	PK2S-2KJE-A	IR850	1000	1.75	950	560	855 nm
	PK2S-2KJE-B	IR850	700	1.60	500	300	855 nm
	PK2S-2KKE-A	IR940	1000	2.00	625	350	940 nm
	PK2S-3KKE-A	IR940	1000	2.95	1190	993	940 nm
	PK2S-3KJE-A	IR850	1000	2.95	1400	780	855 nm
	PK2S-4KJE-A	IR850	1000	1.67	960	505	855 nm
140	PK2S-2LJE-A	IR850	1000	1.75	950	290	855 nm
	PK2S-3LJE-A	IR850	1000	3.13	1560	410	855 nm
	PK2S-4LJE-A	IR850	1000	1.67	960	255	855 nm

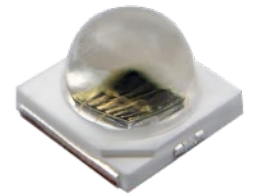

size : 3.45 X 3.45 mm

$2\theta_{1/2}$	Part No.	Color	Test Current (mA)	Vf (Typ.)	mW/sf (typ.)	Radiometric Power (Typ.mW)	λ_p (Typ.)
45	PK2N-1JJE-A	IR850	700	1.7	530	500	855 nm
	PK2N-2JJE-RB	IR850	350	1.5	300	300	855 nm
80	PK2N-1KJE-A	IR850	700	1.7	300	500	855 nm
	PK2N-2KJE-SD	IR850	350	1.5	155	300	855 nm
140	PK2N-1LJE-A	IR850	700	1.7	100	500	855 nm
	PK2N-2LJE-SD	IR850	350	1.5	80	300	855 nm
	PK2N-2LKE-SD	IR940	350	1.5	70	270	940 nm